

电脑包缝机

面板操作说明书

Instructions of overlock sewing machine panel operation

目 录 contents

1. 显示及操作界面 Display and operation menu	2
1.1显示界面介绍 Operation Panel Instructions.....	2
1.2按键设置介绍 button setting Instructions.....	3
2. 常用参数设置 common parameters setting	3
2.1全智能/半智能/全电脑模式的设置.....	3
Automatic/ Semi-automatic/ Full manual mode settings.....	3
2.2抬压脚模式的设置 Presser foot lifter mode setting.....	5
2.3剪线参数的设置 Trimmer parameter setting.....	5
2.4转速的修改 Modify speed.....	6
2.5技术区参数的修改 Change technician parameter.....	7
2.6恢复出厂设置 Restore factory setting.....	7
2.7语音种类设置 Voice language setting.....	8
2.8穿线灯开关的设置 LED light setting.....	8
2.9按键锁定设置 Button lock setting.....	8
3 参数列表 parameters list	9
3.1操作参数说明表 Parameter description.....	10
4 调速器 Speed controller	16

1. 显示及操作界面 Display and operation menu



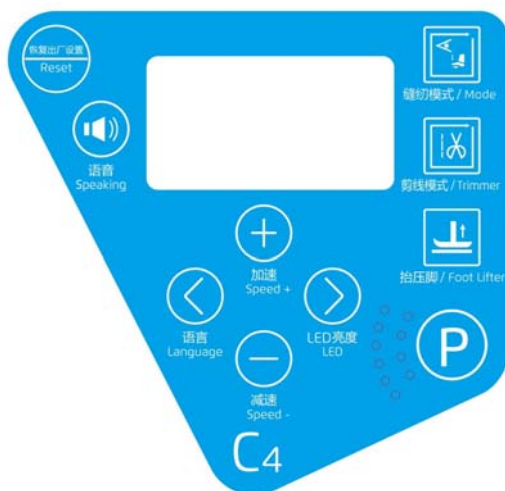





1.1 显示界面介绍 Operation Panel Instructions



序号 No.	图标 Icon	说明 Description	备注 Remark
1		用户参数设置键 Customer parameter settings	
2		左移键 Left button	1、语音种类设置键 Voice language setting 2、参数内容区内，向左选择参数项 Towards the left to choose parameter
3		上移键 Up button	1、向上调速键 Increase speed button 2、参数内容区内，设定数值递增键 Increase the number within a parameter
4		下移键 Down button	1、向下调速键 Decrease speed button 2、参数内容区内，设定数值递减键 Decrease the number within a parameter
5		右移键 Right button	1、机头灯亮度调节 control machine head LCD light brightness 2、参数内容区内，向右选择参数项 Towards the right to choose parameter within a parameter
6		缝纫模式键 Sewing mode button	更改缝纫模式 Change the sewing mode
7		抬压脚功能键 Presser foot lifter function button	更改自动抬压脚模式 Change auto presser foot lifter mode
8		剪线参数设置键 Trimmer parameter setting	更改剪线线头长短及剪线开关 Change the length of the thread and thread switch
9		复位键 Reset button	长按 1.5S 恢复出厂设置 long press for 1.5 seconds restoring factory setting
10		语音导航键 Voice navigation button	语音播报开关 voice broadcast switch

1.2 按键设置介绍 button setting Instructions



长按 P 键 () 约 1.5 秒，将进入用户参数调整模式；通过左移键 () 和右移键 () 修改参数项，按上移键 () 和下移键 () 修改相应参数的值，按 P 键 () 确认并保存，按左移键 () 或右移键 () 不保存并退到参数项设置界面，再次按 P 键 () 退到待机界面。



Long press () for 1.5 seconds and machine will enter the user parameter adjustment mode. Press left button () and right button () to modify the parameter. Press up button () and down button () to modify the value of the corresponding parameter. Press enter button () to confirm and save and press left button () or right button () if user doesn't want to save and will return to the parameter setting interface. Press () again will return to standby interface.

2. 常用参数设置 common parameters setting

2.1 全智能/半智能/全电脑模式的设置

Automatic/ Semi-automatic/ Full manual mode settings

按下缝纫模式选择键 () 时，即可修改缝纫模式；连续按下此键时，缝纫模式按以下三种模式循环：全智能、半智能、全电脑。设置完后按 P 键 () 进行确认保存，5S 无按键则不保存退到待机界面。

Press sewing mode button () ,sewing mode can be modified. Continuous press down this button, sewing mode will be cycled as following three modes: Automatic/ Semi - automatic/ Full manual. Press enter mode () to confirm and save after finishing setting. No Pressing for 5 seconds return to standby interface if user doesn't want to save.

注 1: 参数关联

Notel: Parameter association

在对应模式修改P1最高转速、P3起缝速度、P10自动抬压脚、P17半智能连续缝制、P27前剪线延迟针数、P28后剪线延迟针数、P50防切布传感器延迟针数值时，只更改当前模式下的值，模式切换后，对应参数值同步到当前模式下的参数值。



When modify the parameter in the corresponding mode P1 Max rotate speed、P3 Start sewing speed、P17 Semi - automatic constant rate trimming、P27 The delay stitches number of trimmer before sewing 、P28 delay stitches number of anti - cutting the cloth、P50 the delay stitches number of trimmer after sewing, It only can modify the current mode value, after mode switch, the parameters correspond the value in the current mode.

如：出厂时全智能模式下默认参数为下表第一行参数值，更改 P1 最高转速为 5000 后，更改模式为半智能或全电脑模式时转速更新至 6000，切换回全智能模式时转速回到设置值 5000。

e.g. In automatic mode, the default parameter after factory is the first line parameter values below, modify P1 max rotate speed to 5000r. then modify the mode into semi - automatic and manual, the speed updates to 6000r,when back to automatic mode, the rotate speed back to setting value 5000r.

参数 parameter	全智能默认值 full automatic default value	半智能默认值 semi - automa tic default value	全电脑默认值 Manual default value
P1 最高转速 Max rotate speed	6000	6000	6000
P3 起缝速度 Start sewing speed	5500	5500	5500
P10 自动抬压脚 Auto press foot lifter	3	0	0
P17 半智能连续缝纫模式 Semi - automatic constant rate trimming	1	2	2
P27 前剪线延迟针数 The delay stitches number of trimmer before sewing	2	2	2
P28 后剪线延时针数 Delay stitches number of anti - cutting the cloth	8	8	8
P50 防切布传感器延迟针数 The delay stitches number of trimmer after sewing	0	0	0

2.2 抬压脚模式的设置 Presser foot lifter mode setting

按下抬压脚模式调整键 () 时，即可修改抬压脚模式；连续按下此键时，模式循环如以下几种：前抬、后抬、前后抬、关闭。设置完后按 P 键 () 进行确认保存，5S 无按键则不保存退到待机界面。

Press presser foot function button () to modify presser foot mode.

Continuous press down this button, sewing mode will be cycled as following modes: Front lifter, Back lifter, Front and back lifter, Closed. finish setting, Press enter button () to save and confirm after finishing setting. No Pressing for 5 seconds return to standby interface if user doesn't want to save.





注 2: P10≠0 时，P17 参数自动调整为 1。

注 3: P10=0 时，P17 参数自动调整为 2。



Note 2: when P10≠0, P17 adjust automatically to 1

Note 3: when P10=0, P17 adjust automatically to 2

2.3 剪线参数的设置 Trimmer parameter setting

按下剪线参数设置键 () 时，即可修改剪线状态、前剪线延迟针数或后剪线延迟针数（防切布传感器延迟针数）参数。连续按此键时，参数项循环如下：前剪线开、后剪线开、前后剪线开、关闭、前剪线延迟针数、后剪线延迟针数（防切布传感器延迟针数），按上移键 () 和下移键 () 修改相应参数的值，设置完后按 P 键 () 进行确认保存，5S 无按键则不保存退到待机界面。（每次按键先进入当前剪线状态，按以上顺序循环）

Press trimmer parameter setting button () to modify parameter for trimmer status and the delay stitches number of trimmer before sewing or the delay stitches number of trimmer after sewing. Continuous press down this button, sewing mode

will be cycled as followings: trimmer before sewing on、 trimmer after sewing on、 trimmer both before and after sewing on、off、delay stitches number of trimmer before sewing、 the delay stitches number of trimmer after sewing (the delay stitches number of sensor for anti - cutting the cloth) Press up button () and down button () to modify the value of the corresponding parameter, enter button () to save and confirm after finishing setting. No Pressing for 5 seconds return to standby interface if user doesn't want to save..(every press enter the current trimmer status firstly and cycled as below)

注4: 防切布传感器关闭时 (P32 = 0), 快捷键调节后剪线延迟针数P28参数 (P28默认值为8);

Note4 : When sensor for anti - cutting the cloth off,(P32=0), shortcuts control the delay stitches number of trimmer after sewing P28 parameters.(P28 default is 8)





注 5: 防切布传感器开启时 (P32 = 1), 快捷键调节防切布传感器延迟针数 P50 参数 (P50 默认值为 0) ;

Note5 : When sensor for anti - cutting the cloth on, shortcuts control the delay stitches number of sensor for anti - cutting the cloth P28 parameters.(P50 default is 0)



注 6: 后剪线延迟参数与防切布传感器参数调节时语音播报内容一致。播报: 后剪线参数调节。

Note6: The broadcast voice of the delay stitches number of trimmer after sewing parameter and sensor for anti - cutting the cloth parameter are the same. It reads: after sewing parameters control.



2.4 转速的修改 Modify speed







在待机界面按上移键 () 和下移键 () 可以快速调整最高转速值, 按上移键 () 递增 100 RPM, 按下移键 () 递减 100 RPM。设置完按 P 键 () 进行确认保存, 5S 无按键则不保存退到待机界面。

Press the up button()and down button()in standby interface can rapidly



adjust the highest speed value. Press up button () increases 100 RPM while press down button () decreases 100 RPM. After finishing settings, press enter button () to save the parameter. If customer doesn't want to save, No Pressing for 5 seconds back to standby interface if user doesn't want to save.

2.5 技术区参数的修改 Change technician parameter



按组合键 P 键 () + 抬压脚键 () 约 1.5 秒，将进入技术员参数调整模式，显示 P26，通过左移键 () 和右移键 () 修改参数项，按上移键 () 和下移键 () 修改相应参数的值，设置完按 P 键 () 进行确认保存，5S 无按键则不保存退到待机界面。

Press button () and enter button () together for 1.5 seconds, the machine will enter the technician parameter adjustment mode and the panel will display P26. Press left button () and right button () to change the parameter. Press up button () and down button () to modify the value of corresponding parameter. Press enter button () to confirm and save No Pressing for 5 seconds back to standby interface if user doesn't want to save.



2.6 恢复出厂设置 Restore factory setting



按复位键 () 约 1.5 秒参数将恢复用户保存参数，参数范围为用户参数与技术员参数。按左移键 () 和右移键 () 约 1.5 秒，恢复出厂参数、恢复关联参数。P21 = 1 时按 P 键保存一组用户常用参数，复位键恢复用户保存参数，未保存前出厂参数与用户保存区参数相同，但是 66、67、68 参数不恢复出厂设置。

Press reset button () for 1.5 seconds ,Parameters will restore users saving Parameters. Parameters range from uses parameter to technician parameter, Press left

button () and right button () together for 1.5 seconds, Parameter will restore factory parameters .and associated parameters.when P21=1,P button for saving users common parameters, reset button for restoring users saving parameters, before saving, factory parameters are the same as users saving parameters,but parameter 66,67,68 can not reset to the factory setting.

2.7 语音种类设置 Voice language setting

按左移键 () 切换语音种类，左键按下后，播报当时所选的语音种类，按 P 键 () 确定，更改语音种类。

Press left key () to change voice language,then press “P” key () to save the selected language.

2.8 穿线灯开关的设置 LED light setting

穿线灯亮度分为四档，在待机显示界面，按右移键 () 穿线灯光亮度在 4 个档位间循环调节。（其中一个档位为关闭）

LED light is divided into four gears, On the standby interface ,Press right button () , LCD light brightness will be cycled in four modes.(one is off)

2.9 按键锁定设置 Button lock setting

更改参数项 P62 为 1 时，锁定按键后，按键动作无响应。长按剪线参数设置键 () 约 1.5 秒解除锁定，按键恢复使用。

When modifying parameter P62 to 1,button will be locked and no response. Long Press trimmer parameter () for 1.5 seconds will cancel the lock setting. press restore used.

2.10 语音快捷开关 voice swift switch

长按语音导航键 () 1.5s, 进行语音开关切换。短按语音键进行开机欢迎语音开关切换。出现故障时, 短按语音键播报当前故障解决方法。

Long press voice navigation button () for 1.5s, for voice toggle. Short press voice button for welcome voice switch when start. When failures, short press voice button broadcast solution for failures that happening.

2.11 防切布传感器快捷开关 sensor for anti - cutting the cloth swift switch

长按模式键 () 3s, 进行防切布传感器开关切换。

Long press mode button for 3 seconds, for sensor for anti - cutting the cloth switch toggle.

 **注意:** 进入其他界面时, 不按任何键约5秒不保存退出到待机界面。



When entering the other interface, without saving and don't press any key for 5 seconds will automatically go to the standby interface.

 **注意:** 在自动模式下前感应器设定针数走完之前必须让中感应器触发, 让机器正常运行, 否则会自动停机。

In automatic mode, before needle number that front sensor sets will be done, the middle sensor must be triggered, for machine running normally or the machine will be stopped

 **注意:** 在机器运行时, 任何按键动作都无效, 只有在机器停止后才能进入以上参数设置模式。

When the machine is running, pressing any buttons is invalid. Only after the machine stops can enter the above parameters setting mode.

 **注意:** 当系统报E06 (压脚安全保护) 时, 在压脚放到正确位置后, 按P键 () 清除E06错误。

When the system reports E06(Presser foot safety protection), if presser foot is in the correct place, please press () to solve E06 error;

3 参数列表 parameters list

3.1 操作参数说明表 Parameter description

序号 No.	功能参数 Function parameter	范围 Range	默认值 Default	参数说明 Description
用户区： 按住“P”键 1.5 秒进入 User parameters: Press P button for 1.5seconds to enter				
P1	最高转速 Max rotate speed	500 - 7000	6000	RPM
P2	停针定位选择 Needle stop positioning selection	0 - 2	1	0: 不定位 no needle position 1: 上针位 up needle position 2: 下针位 down needle position
P3	起缝速度 Start sewing speed	500 - 7000	5500	RPM
P4	启动模式 Start up mode	0 - 1	0	0: 自动模式 automatic mode 1: 脚控模式 foot control
P5	模式选择 Sewing mode selection	0 - 2	1	0: 全电脑 manual 1: 半智能 semi - automatic 2: 全智能 full automatic
P6	语音音量调节 Voice volume adjustment	0 - 3	2	0: 关闭 off 1-3: 开启 on
P7	自动剪线 Auto trimming	0 - 3	3	0: 关闭 off 1: 前剪 trimmer before sewing 2: 后剪 trimmer after sewing 3: 前后剪 trimmer both before and after sewing
P8	自动吸气 Auto suction	0 - 3	1 (P60≠2)	0: 关闭 off 1: 前剪线吸气开suction when trimmer before sewing
			3 (P60=2)	2: 后剪线吸气开suction when trimmerafter sewing 3: 前后剪线吸气开suction when trimmer before and after sewing
P9	反踏剪线开关 Counter pedal trimmer	0 - 1	1	0: 关闭 off 1: 开启 on
P10	自动抬压脚 Auto press foot lifter	0 - 3	0	0: 关闭 off 1: 前抬 lifter before sewing 2: 后抬 lifter after sewing 3: 前后抬 lifter both before and after sewing
P11	车缝中途停止时抬压脚 Press foot lifter when sewing stops	0 - 1	0	0: 关闭 off 1: 抬压脚 presser foot lifter

P12	剪完线停止时抬压脚 Press foot lifter after trimming	0 - 1	0	0: 关闭 off 1: 抬压脚 presser foot lifter
P13	半反踏抬压脚 Semi - counter presser foot lifter	0 - 1	1	0: 关闭 off 1: 半反踏或反踏抬压脚 Semi - counter presser foot lifter
P14	手动吸气 Manual suction switch	0 - 2	0	0: 关闭 off 1: 后吸 rear suction 2: 前后吸 front suction and rear suction
P15	机头灯开关 Head lamp switch	0 - 3	1	0: 关闭 off 1-3: 开启 on
P16	休眠功能开关 Dormancy function	0 - 1	1	0: 关闭 off 1: 开启 on
P17	半智能连续缝制 Semi - automatic constant rate trimming	0 - 2	2	0: 关闭 off 1: 前踏可连续缝制 Front step continuous sewing 2: 连续缝纫, 忽略前传感器使能开关 Constant sewing and ignore the front sensor switch
P18	半智能恒速剪线 Semi - automatic constant rate trimming	0 - 1	1	0: 关闭 off 1: 固定前剪线前运行速度 fix the machine speed when front thread trimmer
P19	下位机版本号 Program version No.		V**	电控软件版本号 Control box software version number
P20	上位机版本号 PC version No.		V**	面板软件版本号 Panel software version number
P21	用户常用参数 User common parameters	0 - 1	0	0: 无操作 no operation 1: 保存参数为用户常用参数 saving parameters into user common parameters
P22	前传感器开关 Front sensor switch	0 - 1	1	0: 关闭 off 1: 开启 on
P23	前吸风打开时间 Opening time of manual suction	1 - 250	5	前吸风打开时间 (*100 ms) Opening time of manual suction
P24	吸风关闭时间 Turn off time of suction	0 - 250	0	前吸风关闭时间 (*100 ms) Time when front suction off
P25	后传感器开关 Back sensor switch	0 - 1	1	0: 关闭 off 1: 开启 on
技术员区: 同时按住“P”键和“抬压脚”键进入 Technician parameter: Press P button and Enter button at the same time to enter				
P26	前后传感器间针数 The stitch number between front sensor and	1 - 250	100	

	back sensor			
P27	前剪线延迟针数 The delay stitches number of trimmer before sewing	0 - 10	2	针数越大，线头越短 The bigger of the value, the shorter of the thread length will be after cut
P28	后剪线延迟针数 Delay stitches number of anti - cutting the cloth	0 - 50	8	针数越小，线头越短 The smaller of the value, the shorter of the thread length on the cloth will be
P29	前剪线吸风开启针数 front trimming suction open thread number	1 - 50	1	电机运行后经过P29，前剪线吸风开启 After the motor running to P29, front trimming suction opening
P30	前剪线吸风关闭针数 front trimming suction close thread number	0 - 250	0 (P60≠2) 25 (P60=2)	0: 前剪线吸风与前剪线同步关闭 其他: 前剪线吸风开启后经过P30针数关闭 0: front trimming suction and front trimming synchronous closing Other: when after front trimming suction opening go by P30, thread number closing
P31	后剪线吸风关闭延时 Delay time after back suction off	1 - 50	8	(*100 ms)
P32	防切布传感器开关 sensor for anti - cutting the cloth switch	0 - 1	1 (P60≠2) 0 (P60=2)	0: 关闭 off 1: 开启 on
P33	防切布传感器灵敏度 Sensitivity of sensor for anti - cutting the cloth	20 - 40	36	灵敏度参数越大，越能识别半透明材料 The bigger of the sensitivity parameter, the more capable to identify translucent materials
P34	后传感器与防切布传感器间针数 Stitch number between back sensor and sensor for anti - cutting the cloth	1 - 200	99	
P35	停车延迟针数 Delay stitch number when stop sewing	1 - 99	5 (P60≠2) 35 (P60=2)	
P36	后剪线吸风开启针数 back trimming suction open thread number	1 - 50	3	

P37	前传感器灵敏度 Sensitivity of front sensor	20 - 40	36	灵敏度参数越大, 越能识别半透明材料 The bigger of the sensitivity parameter, the more capable to identify translucent materials
P38	后传感器灵敏度 Sensitivity of back sensor	20 - 40	36	灵敏度参数越大, 越能识别半透明材料 The bigger of the sensitivity parameter, the more capable to identify translucent materials
P39	前抬压脚保持时间 Delay time before presser foot lifter	1- 50	2	(*100ms)
P40	后抬压脚启动时间 Start time after presser foot lifter	0 - 20	0	(*100 ms)
P41	压脚全出力时间 Full output time of presser foot	1 - 50	10	(*10 ms)
P42	压脚出力周期信号 Periodic signal of presser foot output	0 - 50	15	(/10 ms) 开通时间, 总周期 5MS Turn-on time, total cycles 5MS
P43	压脚下放时间 Time of presser foot put down	1 - 99	10	(*10 ms)
P44	压脚保护时间 Time of presser foot protection	1 - 20	5	S
P45	剪线时间 Time of trimmer	1 - 100	40	
P46	连续送布吸气 Continuous feeding and suction	0 - 2	2	0: 关闭吸屑 1: 连续吸屑 2: 吸屑与剪线吸气同步 0: Closed suction crumbs 1: Continuous suction crumbs 2: Suction crumbs and trimming suction in sync
P47	手动剪线动作开关 Manual trimmer switch	0 - 1	1	0: 关闭 off 1: 开启 on
P48	开机自动找上定位 Automatically find up positioning	0 - 1	0	0: 关闭 off 1: 开启 on
P49	压脚关闭周期信号 Periodic signal of presser foot closed	0 - 50	35	(/10 ms) 关闭时间, 总周期 5MS Turn-off time, total cycles 5MS
P50	防切布传感器延迟针数 The delay stitches number of trimmer after sewing	0-50	0	



P51	点针参数 Point needle parameter	0 - 9	3	暂无 no
P52	测试速度 Speed testing	500 - 7000	5500	RPM
P53	测试工作时间 Work time testing	1 - 60	3	S
P54	测试停止时间 Stop time testing	1 - 60	3	S
P55	A 项测试 Testing parameter A	0 - 2	0	0: 关闭 off 1: 开启 on 2: 休眠 dormancy
P56	B 项测试 Testing parameter B	0 - 1	0	0: 关闭 off 1: 开启 on (电磁铁测试) Electromagnet testing
P57	压脚保护开关 Presser foot safety switch	0 - 1	1 (P60≠2)	0: 关闭 off 1: 开启 on
			0 (P60=2)	
P58	缝台保护开关 Sewing plate safety switch	0 - 1	1	0: 关闭 off 1: 开启 on
P59	针杆护罩保护开关 Needle bar cover safety switch	0 - 1	1	0: 关闭 Off 1: 开启 on
P60	电动/气动/侧吸 Electric / pneumatic/side draught	0 - 2	0	0: 电动 electric 1: 气动 pneumatic 2: 侧吸 side draught
P61	休眠时间 Sleeping time	1 - 250	30	分钟 Unit: minutes
P62	面板按键锁定 Panel button lock	0 - 1	0	0: 不锁定 unlock 1: 锁定 lock
P63	降速开关 Slow down speed button	0 - 1	0	
P64	降速针数 Stitch number of slow down speed	1- 200	1	
P65	降速速度 The speed of slowing down	500 - 7000	3500	RPM
P66	前传感器档位调节 Adjusting gear of front sensor	10 - 90	--	参数值越大, 传感器电压值越大 The greater the parameter values.The greater the voltage value of the sensor
P67	后传感器档位调节 Adjusting gear of back sensor	10 - 90	--	参数值越大, 传感器电压值越大 The greater the parameter values,The greater the voltage value of the sensor

P68	防切布传感器档位调节 Adjusting gear of sensor for anti - cutting the cloth	10 - 90	--	参数值越大，传感器电压值越大 The greater the parameter values, The greater the voltage value of the sensor
P69	计件数计数单位 Unit number counting	1 - 50	10	设置每件剪线次数 Setting per unit trimmer number
P70	计件数总数设定 Total counting setting	1-9999	100	
P71	计件数计数模式 Counting mode	0 - 5	0	0: 关闭; off 1: 升序循环计数; ascending cycle count 2: 降序循环计数; descending cycle count 3: 升序计满报警; ascending full alarm 4: 降序计满报警; descending full alarm 5: 清除计满报警; remove full alarm
P72	强制后剪线延迟针数 The stitches number of constraint back trimmer	0 - 20	9	布料前剪线后离开前、后感应器且未遮住第三感应器经过设定针数后执行后剪线。 Adjust the back trimmer function even the fabric does not cover the anti-cutting sensor, can adjust the stitches number before the trimmer function active
系统员参数 (P+上键, 设置三位密码“111”, 按“P”进入)				
Member of the system parameters (P+up key, Set up three passwords “111”, press “P” to enter)				
P81	同步吸气, 前吸屑关闭针数 Synchronous inspiratory, front suction crumbs close thread number	0 - 250	0	0: 前吸屑与前剪线吸气同步关闭 其他: 前吸屑开启 P81 针数后关闭, 但不能比前剪线吸气提前关闭。 0: front suction crumbs and front trimming inspiratory synchronous closing Other: when after front suction crumbs opening go by P18, thread number closing, but can't shut down earlier than front trimming inspiratory
P82	同步吸气, 后吸屑关闭针数 Synchronous inspiratory, back suction crumbs close thread number	0 - 250	0	0: 后吸屑与后剪线吸气同步关闭 其他: 后吸屑开启 P82 针数后关闭, 但不能比后剪线吸气提前关闭。 0: back suction crumbs and back trimming inspiratory synchronous closing Other: when after back suction crumbs opening go by P82, thread number closing, but can't shut down earlier than back trimming inspiratory

P83	前剪线松线电磁阀开启针数 Front trimming loose line solenoid valve open thread number	0-50	1	0: 前剪线松线电磁阀关闭 其他: 前剪线松线电磁阀经(P83)-1 针数开启 0:Front trimming loose line solenoid valve opening Other:Front trimming loose line solenoid valve go by (P83)-1 open thread number
P84	前剪线松线电磁阀关闭针数 Front trimming loose line solenoid valve close thread number	1-50	1	
P85	后剪线松线电磁阀开启针数 back trimming loose line solenoid valve open thread number	1-50	1	0: 后剪线松线电磁阀关闭 其他: 后剪线松线电磁阀经 P85 针数开启 0:back trimming loose line solenoid valve closing Other:back trimming loose line solenoid valve go by P85 open thread number
P86	后剪线松线电磁阀关闭针数 back trimming loose line solenoid valve close thread number	1-50	10	
P87	手动吸气持续时间 Duration time of manual suction	1-50	3	(*100ms)
P88	手动吸气电机转速 Speed of manual suction motor	500 - 7000	3500	

注 7: 系统员参数

1、说明书未提及参数，请勿随意更改！

2、按 P+上键，面板显示“000”，分别按  进行密码设置。

Note 7: Member of the system parameters

1、The parameters didn't be mentioned in specification , please do not change!

2、Press p+ up key, panel display “000” ,press   for password

4 错误码说明表



机器出错报警时，语音播报当前故障，如面板显示 E03 时，语音播报“操作面板与控制器箱通讯异常”，按下语音导航键（）播报故障原因及解决办法“请检查操作面板和控制箱连接线是否松动；请尝试恢

复出厂设置或将电源重启；上述如仍无法解决请联系当地服务商或拨打 4008876858”。在播报时按下 P

键 () 或语音键将停止当前播报内容。（故障恢复，语音停止播报）

序号	内容 (出现故障则播报)	对策 (按下语音导航键 () 播报)
E1	Motor stalled	Pls check whether the machine head stuck or not, or rotate very tough; pls check whether the motor plug and sensor connection loose or not; if cannot solve the problem, pls contact the local agent.
E2	Software over current	Pls check the voltage normal or not; pls reset the machine or restart; if cannot solve the problem, pls contact the local agent .
E3	The connection problem of panel and control box	Pls check the connection of panel and control box loose or not; pls reset the machine or restart; if cannot solve the problem, pls contact the local agent .
E4	The motor hall signal abnormal	Pls check whether the motor plug connection loose or not, whether the wire broken or not, change motor.
E5	The fault of needle stop position signal	Pls check whether the plug and handwheel magnet loose or not.
E6	Presser foot safety switch wrong position	Pls check whether the presser foot back to the correct position or not; if not working, pls change the value number 1 to 0 of P57; if cannot solve the problem, pls contact the local agent.
E7	Sewing bed safety switch wrong position	Pls check whether the sewing bed back to the correct position or not; if not working, pls change the value number 1 to 0 of P58; if cannot solve the problem, pls contact the local agent.
E8	Needle bar safety switch wrong position	Pls check whether the sewing bed back to the correct position or not; if not working, pls change the value number 1 to 0 of P59; if cannot solve the problem, pls contact the local agent.
E9	Pedal connection problem	Pls check whether the connection of pedal and control box loose or not; if cannot solve the problem, pls contact the local agent.
E10	Hardware over current	Pls check the voltage; pls reset the machine or restart; if cannot solve the problem, pls contact the local agent .
E11	Stop over voltage	Pls check the voltage; pls reset the machine or restart; if cannot solve the problem, pls contact the local agent .
E12	System under voltage	Pls check the voltage; pls reset the machine or restart; if cannot solve the problem, pls contact

		the local agent 。
E13	Brake circuit	Pls contact the local agent.
E14	Parameter read and write problem	If cannot solve the problem, pls restart the machine or contact the local agent.
E15	The protection of motor over speed	
E16	Motor reversal	Reset the machine
E17	Running over voltage (no)	Pls reset the machine; if cannot solve the problem, pls contact the local agent 。
E18	Motor overload	Pls check whether the material is too heavy or not; Pls check whether the machine head stuck or not, or rotate very tough; pls check whether the motor plug and sensor connection loose or not; if cannot solve the problem, pls contact the local agent.
E19	Current detection circuit problem	If cannot solve the problem, pls restart the machine or contact the local agent 。
E20	Power off	
E24	The voice chip work problem	Pls reset machine or turn off the power and turn on If cannot solve the problem, pls restart the machine or contact the local agent 。
E26	The communication between the transfer board and the controller problem	Pls check the wire between the transfer board and the controller Pls reset or turn off the power and turn on . If cannot solve the problem, pls restart the machine or contact the local agent 。
E27	The reset problem	Turn off machine and turn on, reset machine.
EA1	Counting problem	Press P to remove, or set P71 value 5。
EA2	Counting problem	Press P to remove, or set P71 value 5。

注意：当系统报 E06（压脚安全保护）时，在压脚放到正确位置后，按 P 键（）清除 E06 错误。

Attention:When system show E06(presser foot protection) Put the presser foot to right position and Press P to remove the Erro.

5 调速器 Speed controller

将调速器（件 1）按下图所示的方向，使用 4 颗 ST4.8 自攻螺钉（件 2）将调速器安装到台板下方合适的位置。

Use four pieces ST4.8 tapping screw (Part No.2) to install the above speed controller under the stand & table to the right position.

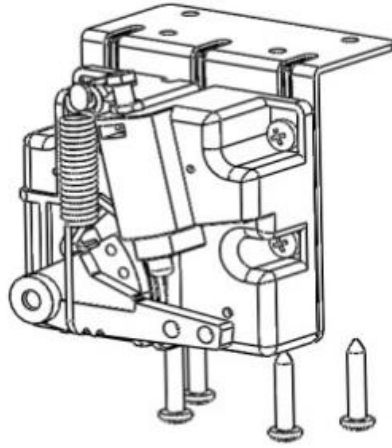

序号 NO.	名称 Parts description	数量 pcs
1	调速器 Speed Controller	1
2	十字槽盘头自攻螺钉 ST4.8×22 Tapping Screw ST4.8×22	4